

ELLIS

Holding Power

DATA SHEET

2A CLAMPS

- 2 HOLE CLAMPS CAST IN LM6 ALUMINIUM
- ROBUST DESIGN OFFERS GOOD RESISTANCE TO CABLE FORCES
- CLAMPING RANGE OF $\varnothing 32$ - $\varnothing 168$ MM ACHIEVED ACROSS 18 SIZES
- SHORT CIRCUIT AND MECHANICALLY TESTED TO IEC 61914
- FIXINGS ARE NOT SUPPLIED AS STANDARD BUT CAN BE SUPPLIED ON REQUEST

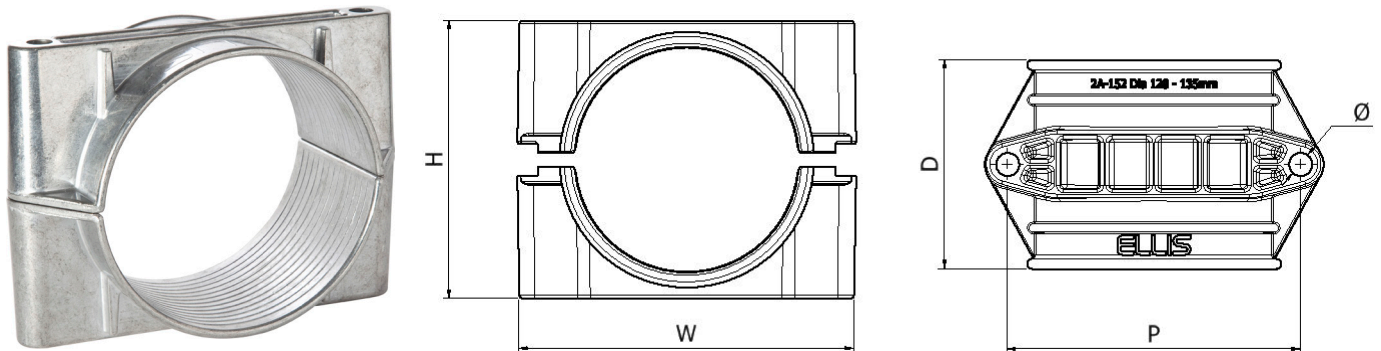

PART NO.	CABLE RANGE		LINER THICKNESS (mm)	CABLE RANGE WITH LINER		DIMENSIONS (mm)					WEIGHT (g)	AXIAL LOAD	LATERAL LOAD - HORIZONTAL	LATERAL LOAD - VERTICAL
	MIN \varnothing (mm)	MAX \varnothing (mm)		MIN \varnothing (mm)	MIN \varnothing (mm)	W	H	D	P	\varnothing				
2A-07N	38	46	3	32	40	94	57	49	68	2 x M10	174	800N	12.5kN	25kN
2A-08N	46	51	3	40	45	104	60	49	79	2 x M10	214	800N	12.5kN	25kN
2A-09N	51	57	3	45	51	105	68	49	79	2 x M10	224	800N	12.5kN	25kN
2A-10N	57	64	3	51	58	105	76	49	79	2 x M10	234	800N	12.5kN	25kN
2A-11N	64	70	3	58	64	133	75	64	106	2 x M10	360	800N	12.5kN	25kN
2A-1200N	70	76	3	64	70	133	87	64	106	2 x M10	376	800N	12.5kN	25kN
2A-1201N	76	83	3	70	77	133	95	64	106	2 x M10	388	800N	12.5kN	25kN
2A-1202N	83	90	3	77	84	133	102	64	106	2 x M10	392	800N	12.5kN	25kN
2A-131N	90	97	4	82	89	154	109	76	126	2 x M10	520	800N	12.5kN	25kN
2A-132N	97	105	4	89	97	154	118	76	126	2 x M10	524	800N	12.5kN	25kN
2A-141N	105	112	4	97	104	165	126	76	135	2 x M10	590	800N	12.5kN	25kN
2A-142N	112	120	4	104	112	173	133	76	143	2 x M10	642	800N	12.5kN	25kN
2A-151N	120	128	5	110	118	196	157	125	168	2 x M12	1700	5.5kN	20kN	50kN
2A-152N	128	135	5	118	125	203	166	125	176	2 x M12	1840	5.5kN	20kN	50kN
2A-161N	135	144	5	125	134	222	178	150	190	2 x M16	2633	6kN	35kN	60kN
2A-162N	144	152	5	134	142	232	188	150	200	2 x M16	2856	6kN	35kN	60kN
2A-171N	152	160	5	142	150	242	199	150	210	2 x M16	3089	6kN	35kN	60kN
2A-172N	160	168	5	150	158	252	210	150	220	2 x M16	3332	6kN	35kN	60kN



FOR THE LINERED VERSION ADD 'L' AS A SUFFIX TO THE PART NO. E.G. '2A-07NL'.

ELLIS PATENTS LTD.

www.ellispatents.co.uk

ISSUE 03 02/05/19

1 / 2

TESTING SUMMARY

2A Clamps have been tested in line with the International Standard 'Cable Cleats for Electrical Installations' IEC 61914:2015. Typical results are detailed below, please note that these testing values are maximums and safety factors appropriate to your application should be used:

PROPERTY	CLASSIFICATION CLAUSE IEC 61914	UNITS / CLASSIFICATION	TEST DATA
CLEAT TYPE	6.1, 6.1.3	METALLIC	-
TEMP. FOR PERMANENT APPLICATION	6.2	°C	-40 - 90
UV RESISTANCE	6.5.1.2	N/A	-
CORROSION RESISTANCE	6.5.2.2	HIGH	ALUMINIUM IS NON-FERROUS
IMPACT RATING	6.35	VERY HEAVY	PASS
FLAME PROPAGATION TEST	10.0, 10.1	APPLICATION TIME $\geq 30s$	N/A
AXIAL LOAD RATING	6.4.3, 9.4	NEWTONS (N)	REFER TO THE DATA TABLE ON PAGE 1
LATERAL LOAD RATING	6.4.2, 9.3	NEWTONS (N)	REFER TO THE DATA TABLE ON PAGE 1
RESISTANCE TO ELECTROMECHANICAL FORCE (SHORT CIRCUIT TESTING)	6.4, 6.4.4, 9.5	CLEATS AT 300MM INTERVALS (WITHSTANDING ONE SHORT CIRCUIT)	183kA (REPORT No. PDL- 18.071.1) CABLE OD= $\varnothing 36mm$ PHASE SPACING = 100MM
RESISTANCE TO ELECTROMECHANICAL FORCE (SHORT CIRCUIT TESTING)	6.4, 6.4.5, 9.5	CLEATS AT 1M INTERVALS (WITHSTANDING MORE THAN ONE SHORT CIRCUIT)	113kA (REPORT No. PDL- 15.025.1) CABLE OD= $\varnothing 117mm$ PHASE SPACING = 200MM

The test data provided above is for the standard version only, for test data with the liner option please contact Ellis.

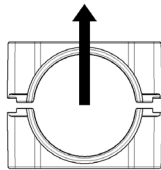

LATERAL LOAD 'VERTICAL' DIRECTION

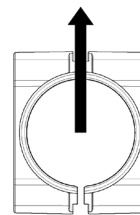

LATERAL LOAD 'HORIZONTAL DIRECTION'

This data sheet is subject to change without notice. The information provided has been generated in laboratory conditions, as such results in use may vary.