

Colossus Data Sheet (Trefoil)

Colossus Cable Cleat (Trefoil)

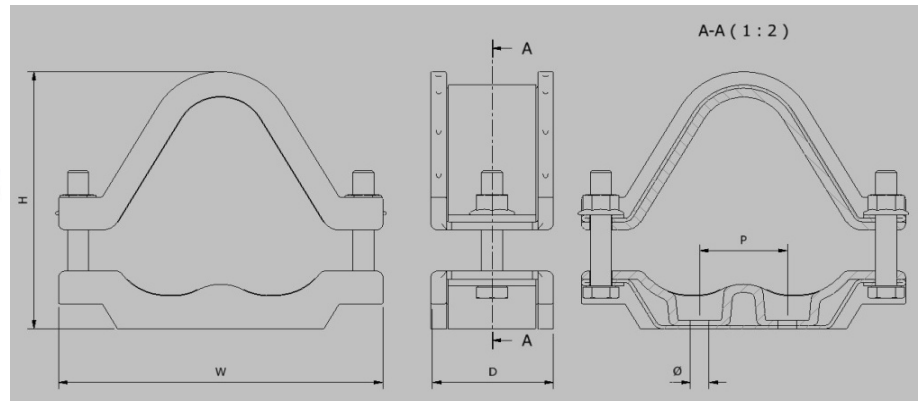

Colossus Cleat

Part No	Cable Range		Dimensions					Weight g
	Min Dia mm	Max Dia. mm	W mm	H mm	D mm	P mm	∅ Fixing Holes	
COL24-29	24	29	128	87	60	25	2 x M10 + M12	604
COL27-32	27	32	133	92	60	25	2 x M10 + M12	623
COL30-36	30	36	137	101	60	25	2 x M10 + M12	639
COL34-41	34	41	146	110	60	25	2 x M10 + M12	690
COL39-47	39	47	157	122	60	25	2 x M10 + M12	734
COL45-54	45	54	171	141	70	50	2 x M10	913
COL52-62	52	62	185	156	70	50	2 x M10	974
COL60-72	60	72	204	176	70	50	2 x M10	1063
COL69-83	69	83	225	202	100	75	2 x M12	1590
COL79-95	79	95	247	225	100	75	2 x M12	1700
COL91-109	91	109	273	253	100	120	2 x M12	1900
COL105-126	105	126	306	286	150	120	2 x M12	3030
COL122-146	122	146	345	324	150	150	2 x M12	3270
COL142-170	142	170	390	371	150	150	2 x M12	3680

Saddled Colossus Cleats:

Part No	Cable Range		Dimensions					Weight g
	Min Dia mm	Max Dia. mm	W mm	H mm	D mm	P mm	∅ Fixing Holes	
COL69-83SC	69	83	225	202	300	75	2 x M12	TBA
COL79-95SC	79	95	247	225	300	75	2 x M12	TBA
COL91-109SC	91	109	273	253	300	120	2 x M12	TBA
COL105-126SC	105	126	306	286	300	120	2 x M12	3400
COL122-146SC	122	146	345	324	300	150	2 x M12	TBA
COL142-170SC	142	170	390	371	300	150	2 x M12	TBA

Issue 03 13/10/2016

Testing Information

Colossus Cleats have been tested in line with the International Standard of 'Cable Cleats for Electrical Installations' IEC 61914:2009. Typical results are detailed below:

Properties	IEC 61914:2009 Classification Clause	Units / Classification	Colossus Trefoil Cable Application Test Data
Cleat Type	6.1, 6.1.3	Composite	-
Impact Resistance	6.3, 6.3.5, 9.2	Very Heavy Classification (5kg @ 400mm)	Pass
Resistance to Electromechanical Force (undertaken at ZKU Laboratories CZ)	6.4, 6.4.3, 9.5	104kA @ 7.8m (with intermediate straps every 1.3m centres M12 Fixings (withstanding two short circuits))	Refer to Ellis Patents for test certificate
Temperature for Permanent Application	6.2	°C	-40 to 60
Needle Flame Test	10.0, 10.1	Application Time (seconds)	>120
Lateral Load Test	9.3	Newtons (N)	7,500
Axial Movement Test	9.4	Newtons (N)	Refer to Ellis Patents for details